



JUEGO MASTER DE INYECTORES 5158 ***INJECTOR PULLER MASTER KIT 5158***



Manual de instrucciones *Manual instructions*



ES

MI5158
Rev. 2 - 05.01.2023

Contacto: ventas@forza.es / www.forza.es



EN

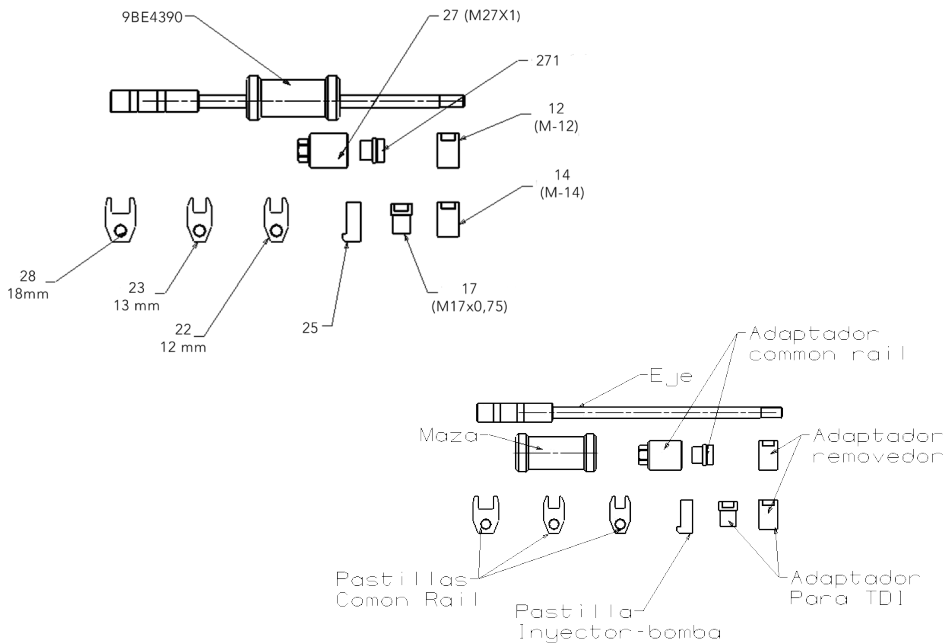
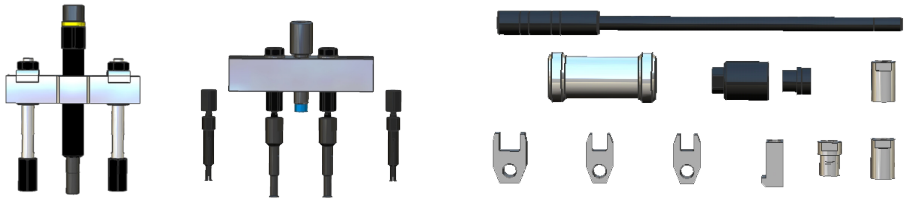

Juego Master de Inyectores

- 4390 Barra de Impacto
- 5152 Puente regulable
- 5154 Extractor de inyectores con 4 pinzas y 8 Adaptadores para extraer inyectores.

Injector Puller Master Kit

- 4390 Slide hammer
- 5152 Adjustable push bar
- 5154, Injector puller with 4 expanding collets and 8 adaptors to remove injectors.

Instrucciones generales / General instructions



1- Mantenga las normas de higiene y seguridad en el trabajo. /
Keep the standards of hygiene and safety at work.

2- Utilice los elementos de protección individual obligatorios. /
Always wear suitable personal protective equipment.

Puente 5152 / Push puller 5152

Alargadera ajustable en altura para culatas desiguales.

Height adjustable extenders for uneven cylinder head.

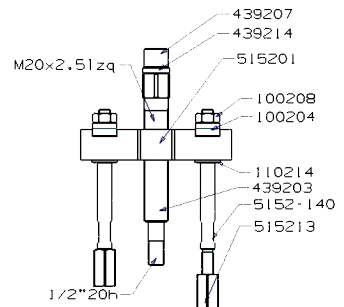
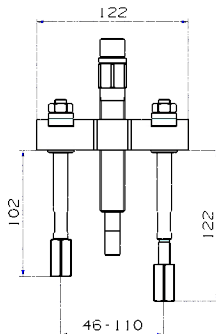
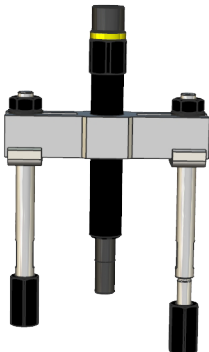
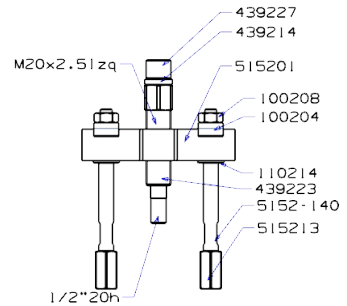
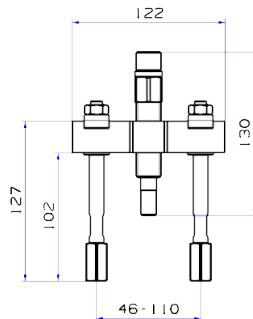
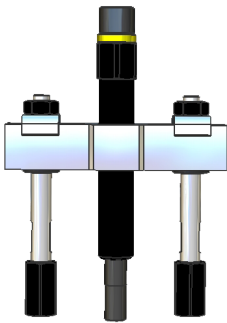

Aplicaciones / Applications

- Extraer con la barra y adaptadores removedores.
- *Pull out with slide hammer and adaptor remover.*

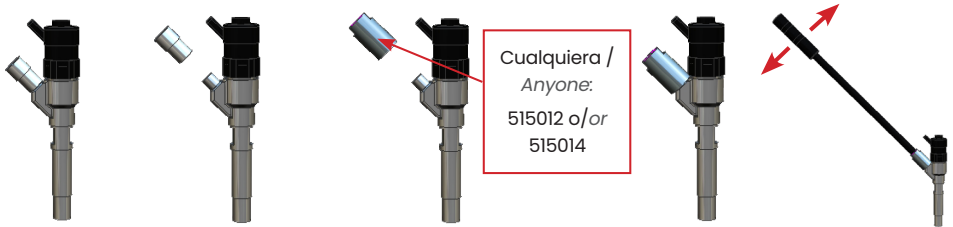

- 1- Quitar todo los manguitos e inyectores.
- 2- Colocar el adaptador roscado adecuado.
- 3- Colocar la barra de impacto y balancear suavemente el inyector hacia los lados para liberarlo.

- 1- Dismantle every fuel pipe and injector plug.
- 2- Mount proper threaded adaptor.
- 3- Mount slide hamer and rock injector gently sideways to set it free.

- Extraer con llave adaptadora.
- *Pull out with wrench-adaptor.*

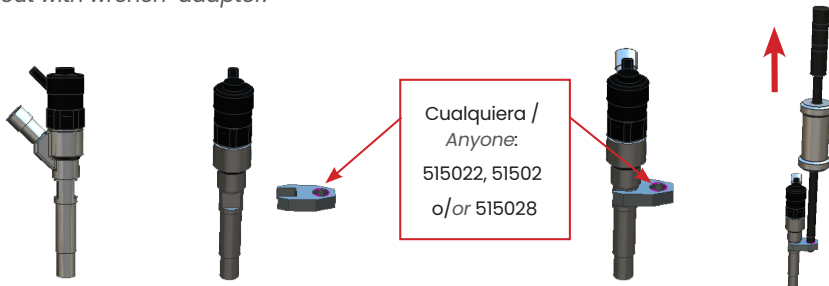

- 1- Quitar todo los manguitos e inyectores.
- 2- Colocar el adaptador roscado adecuado.
- 3- Colocar la barra de impacto y balancear suavemente el inyector hacia los lados para liberarlo.

- 1- Dismantle every fuel pipe and injector plug.
- 2- Mount proper threaded adaptor.
- 3- Mount slide hamer and rock injector gently sideways to set it free.

- Extraer con adaptador roscado.
- *Pull out with threaded adaptor.*



- 1- Quitar todos los manguitos e inyectores.
- 2- Quitar la tapa del inyector.
- 3- Colocar el protector 5150271.
- 4- Colocar el adaptador roscado 515027.
- 5- Colocar la barra de impacto y extraer.

- 1- Dismantle every fuel pipe and injector plug.
- 2- Dismantle the injector cap
- 3- Mount protector 5150271
- 4- Mount threaded adaptor 515027
- 5- Mount slide hamer and pull out

- Extraer con el adaptador 515025
- *Pull out whit 515025 adaptor*

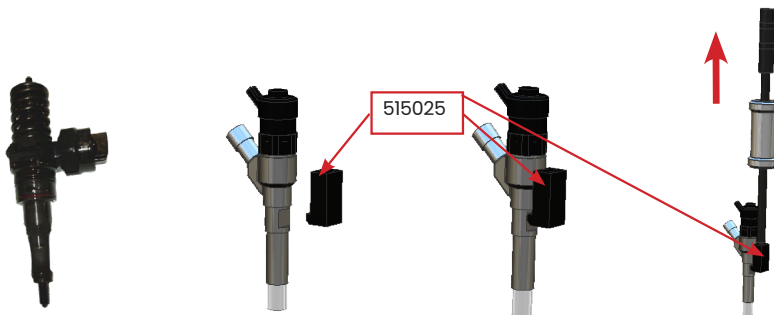

Extraer Inyectores bomba o inyectores con brida con las pinzas.
Pulling out of spring loaded injectors or Siemens type injectors with 2 sides holes.

- Extracción de inyectores con muelle o inyectores tipo Siemens con agujeros en ambos lados
- Pulling out spring loaded injectors or Siemens type injectors with holes on both sides



Inyector tipo Siemens con agujeros en ambos lados. / Siemens type injector with holes on both sides.



Inyector con muelle Volkswagen. / Spring loaded Volkswagen injector.

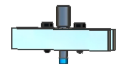
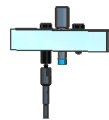
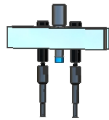
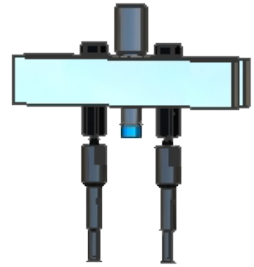

Montar las pinzas. / Mount expanding collets.



Apretar los tornillos / Tighten screws.

Girar el husillo para sujetar el extractor. **NO** apretar. / Turn spindle to hold puller in place, Do **NOT** push.



S.L. de Herramientas Especiales Forza
San Miguel de Acha, 24
010110 Vitoria-Gasteiz (España)
Tlf.: 945 24 97 16